



Tension Shading System 100 Internal unguided tension system



Application

STS 100 is primarily designed for commercial buildings such as offices, shops, hotels and airports.

The STS 100 is suitable for rectangular fabric shades installed under horizontal, vertical or sloping glazing, including drawing vertically bottom to top. With additional relieving rollers the system can also change direction to profile non-linear or curved glazed surfaces.

Design Specifications

- A single 85 mm galvanized steel roller incorporating both the drive motor and the spring compensation cassette with integral tension adjustment gear.
- Extruded aluminium hem bar supporting the free end of the fabric.
- A continuous nylon coated tension cable to deploy and retract the blind.
- Two 6.5 m capacity cable drums, one on either end of the fabric roller.

Design Options

- Relieving roller for intermediate fabric support. (Recommended for draw over 3 m).
- Boat shaped hem bar end caps to allow smooth passage over relieving rollers.

Finishes

- Aluminium components - polyester powder finish, 30% gloss.
- Steel - galvanised against corrosion.

Installation

- Supplied with universal roller brackets and return pulleys suitable for top or back fix.

Maximum width: 3 m

Maximum draw: 6.5 m

Maximum fabric area: 16 m²

Maximum fabric weight: 450 g/m²

STS 100 Components

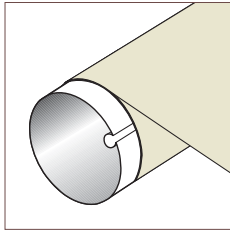

1 Fabric roller

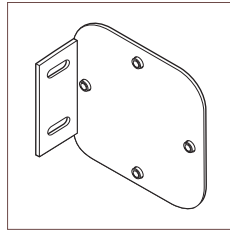

2 Cheek plate

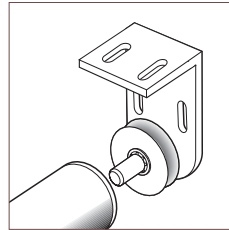

3 Relieving roller bracket

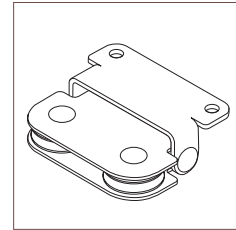

4 Universal return pulley

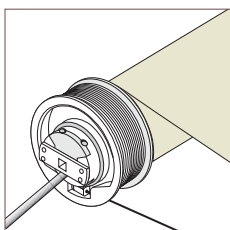
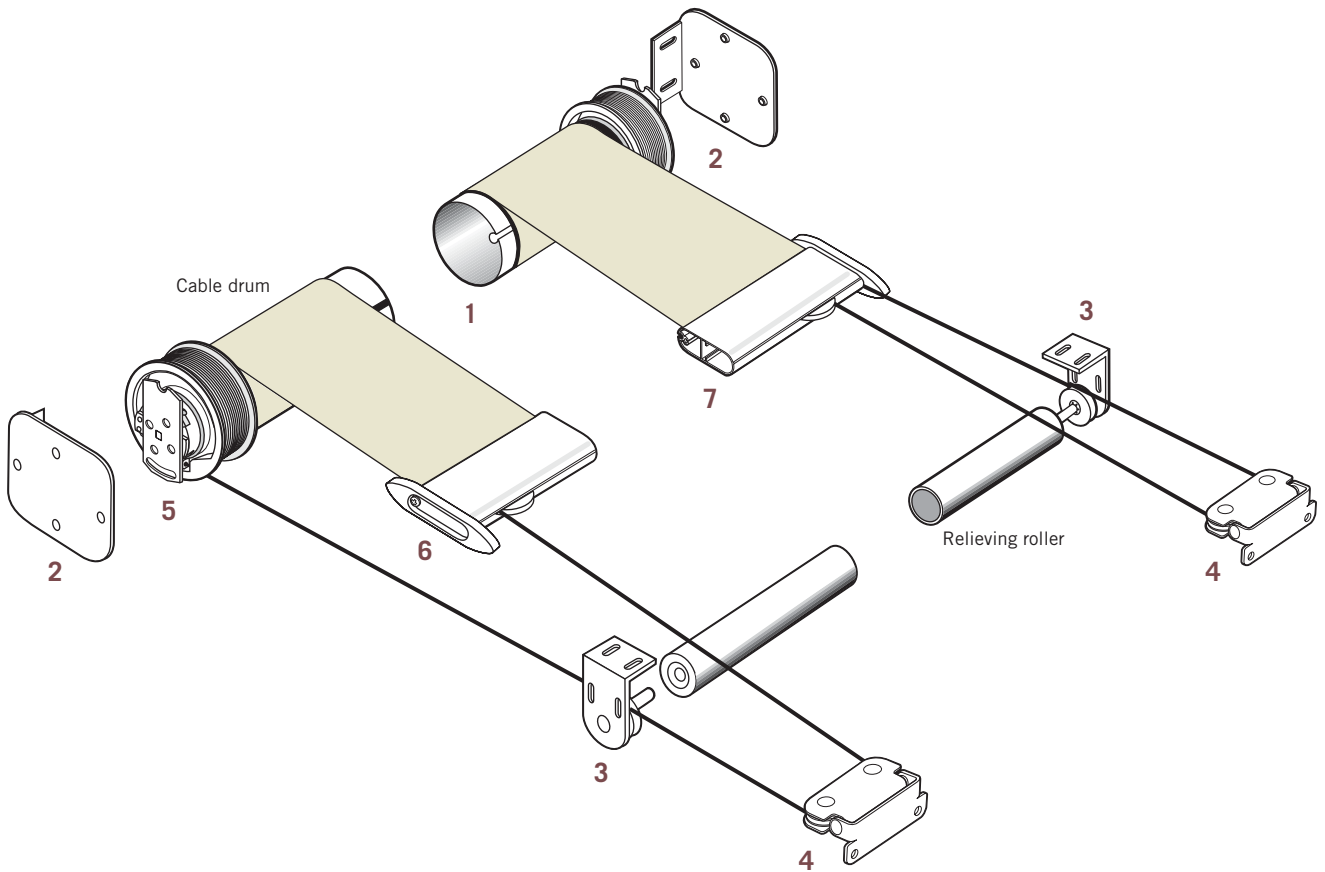

5 Motor with cable spool - without mounting plate

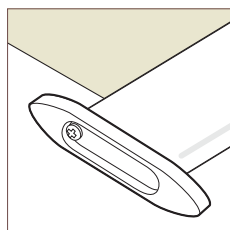

6 Hem bar end cap for system with relieving roller

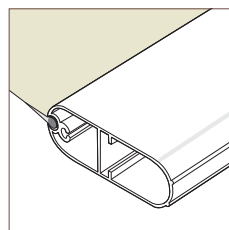

7 Hem bar

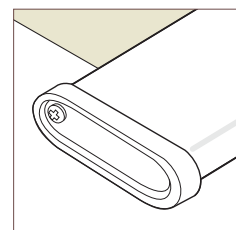

Hem bar cap for system without relieving roller

STS 100 Technical specifications

Model		T10775
Maximum width	(m)	3
Maximum draw	(m)	6.5
Maximum fabric area	(m ²)	16
Basic weight	(kg)	7.5
+ Per metre width	(kg)	4.2
Typical fixing load	(kg)	24
Maximum fixing load	(kg)	36
Motor		
Torque	(Nm)	15
Speed	(min ⁻¹)	17
Current at 230 V	(A)	0.65
Cable length	(m)	2.5
Temperature range	(°C)	-5 to +55
Maximum run time	(min)	4
Minimum fabric speed	(m/min)	5

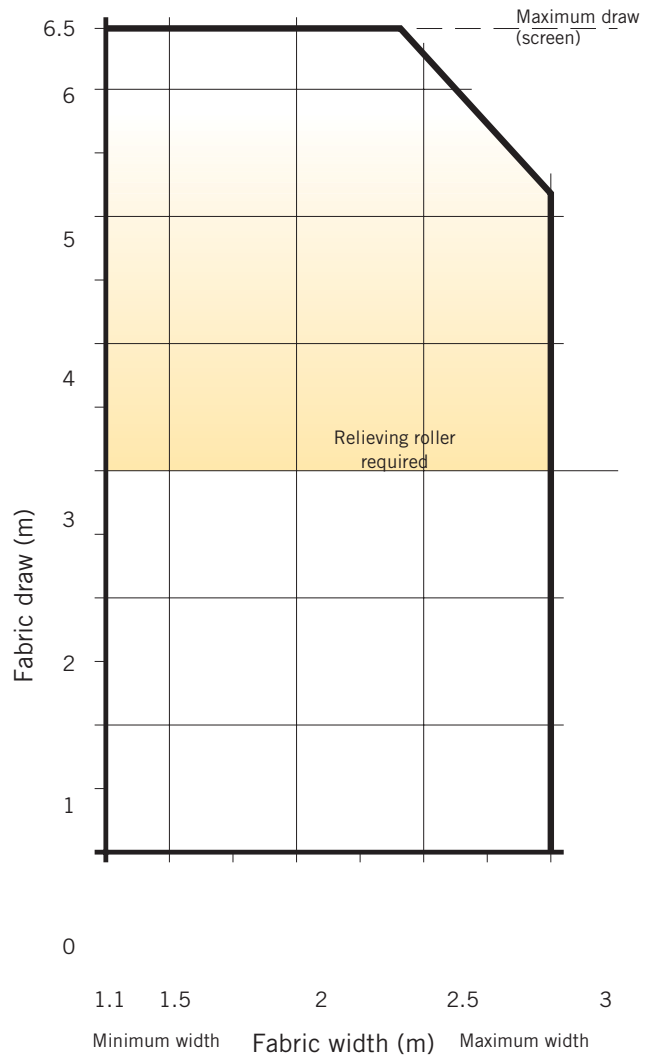

Maximum fabric area: 16 m²
 Maximum fabric weight: 450 g/m²
 Minimum width Std motor: 870 mm
 Minimum width Radio motor: 1230 mm

STS 100 Installation

Top fix

Back (face) fix

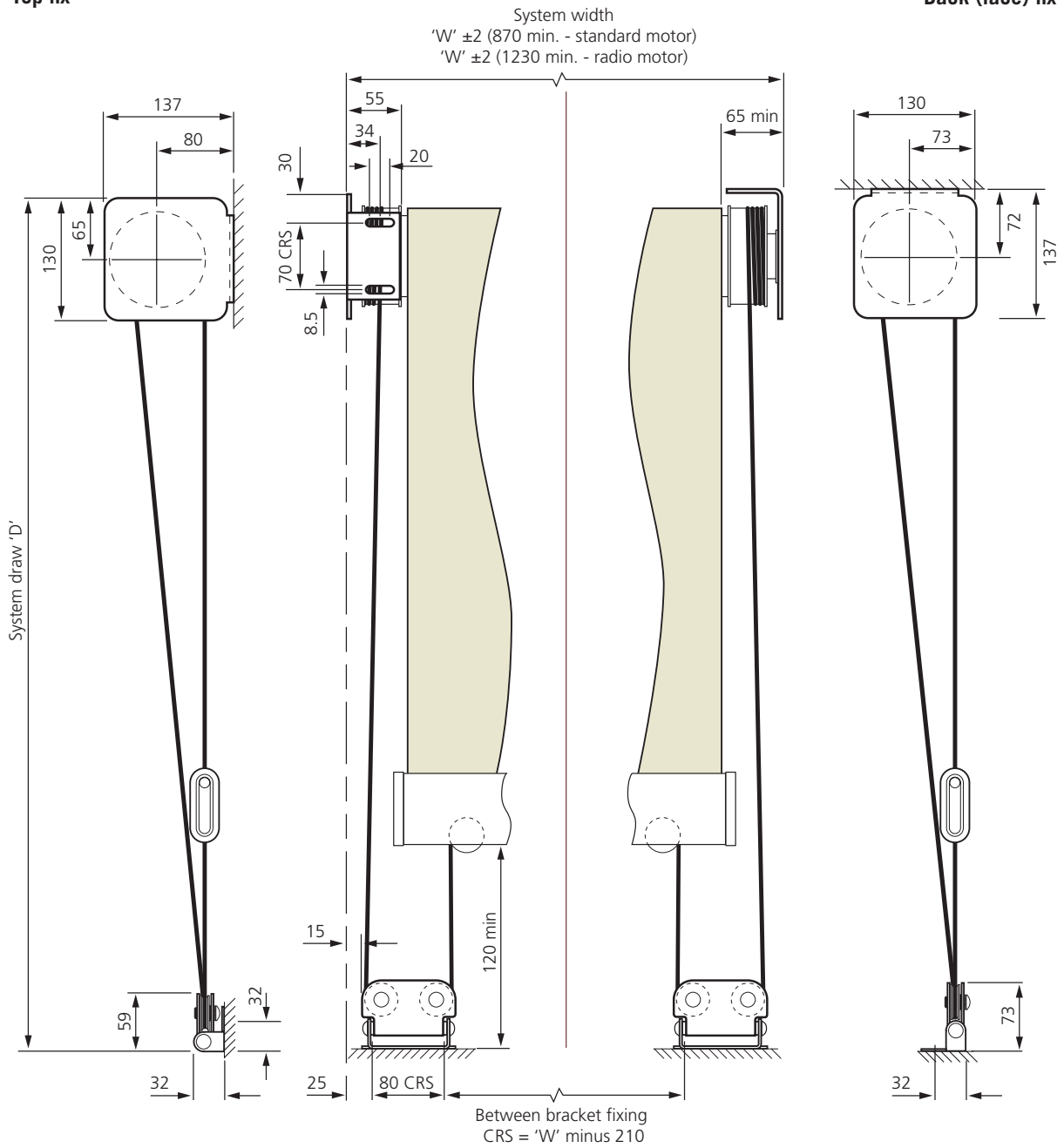

All dimensions in mm